

3D PDF DATASHEET



eCATALOG solutions



BIM catalogs.net



PARTsolutions



Create Your Individual 3D PDF Datasheet ▶

Learn How to Create Your Mechanical Product Catalog ▶

Learn How to Create Your BIM Product Catalog ▶

Reduce Your Costs in Engineering and Purchasing ▶



PARAB-14F Corr. Tubing PARAB

3D View

To activate the interactive 3D view, you must trust this document (see hint on the top) in Adobe Acrobat and click on the question mark.

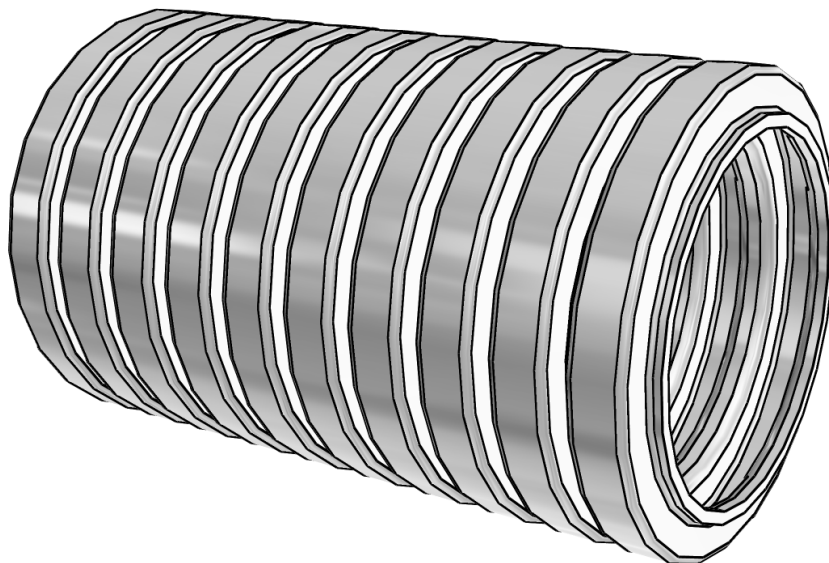

Zoom

Moves you toward or away from objects in the scene when you drag vertically. You can also zoom with the hand tool by holding down Shift as you drag.

Pan

Moves the model vertically and horizontally only. You can also pan with the hand tool: Ctrl-drag.

Rotate

Turns 3D objects around relative to the screen. How the objects move depends on the starting view, where you start dragging and the direction in which you drag.

3D PDF DATASHEET



 eCATALOG solutions



 BIM catalogs.net



 PART solutions



Create Your Individual 3D PDF Datasheet 

Learn How to Create Your Mechanical Product Catalog 

Learn How to Create Your BIM Product Catalog 

Reduce Your Costs in Engineering and Purchasing 



PARAB-14F Corr. Tubing PARAB

2D Derivation

ISO View

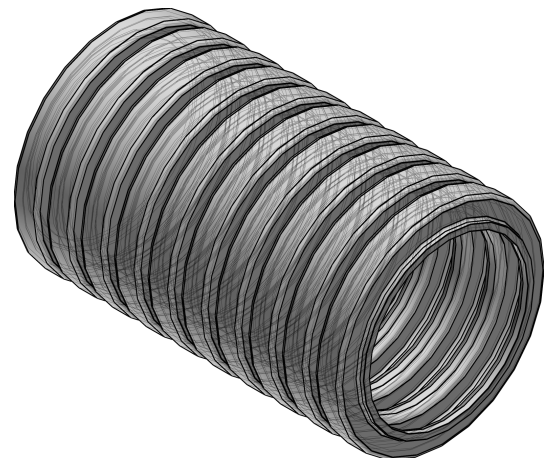
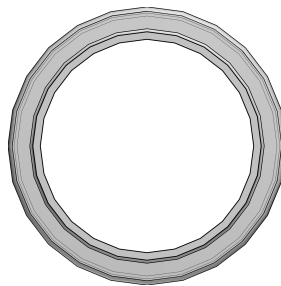
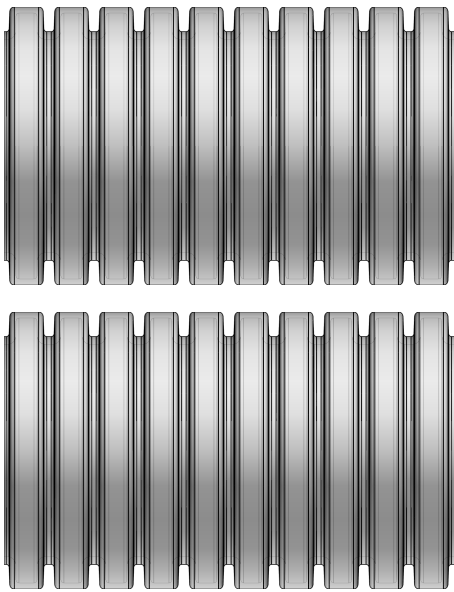



eCATALOGsolutions



BIM catalogs.net



PARTsolutions



Create Your Individual 3D PDF Datasheet



Learn How to Create Your Mechanical Product Catalog



Learn How to Create Your BIM Product Catalog



Reduce Your Costs in Engineering and Purchasing



PARAB-14F Corr. Tubing PARAB

Technical Drawings

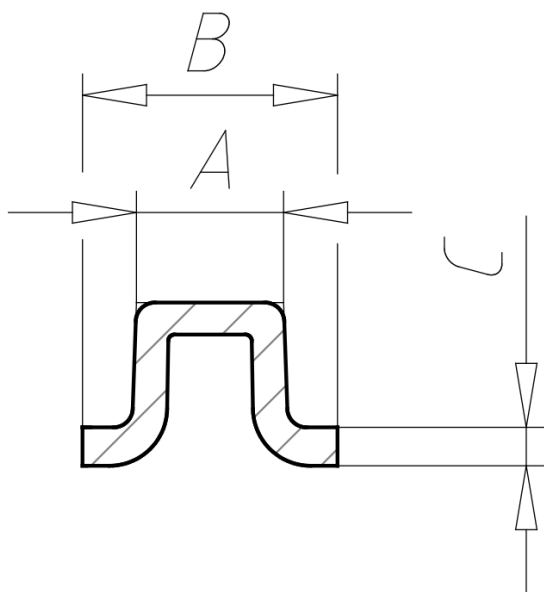
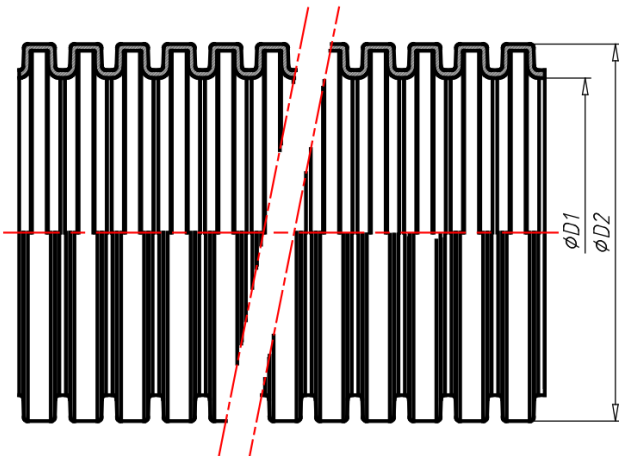

3D PDF DATASHEET



 eCATALOG solutions



 BIM catalogs.net



 PART solutions



Create Your Individual 3D PDF Datasheet 

Learn How to Create Your Mechanical Product Catalog 

Learn How to Create Your BIM Product Catalog 

Reduce Your Costs in Engineering and Purchasing 



PARAB-14F Corr. Tubing PARAB

Technical Data

INFO (PDF Info)	Data Sheet
FB (Color)	black
NW (Nominal width)	14F
A (Length / mm)	2.2
B (Length / mm)	3
C (Height / mm)	≥ 0.30
D2 (Diameter / mm)	18.5
D1 (Diameter / mm)	14.2
BRS (Bending radius (stat.) / mm)	30
BRD (Bending radius (dyn.) / mm)	80
CNSMASSEXACT (Weight / kg/100m)	4.7
VE (Purch. Unit / m)	50

3D PDF DATASHEET



 eCATALOG solutions



 BIM catalogs.net



 PART solutions



Create Your Individual 3D PDF Datasheet 

Learn How to Create Your Mechanical Product Catalog 

Learn How to Create Your BIM Product Catalog 

Reduce Your Costs in Engineering and Purchasing 



PARAB-14F
Corr. Tubing PARAB

Bill of Materials

N°	Name	Description	Amount
1.1		PARAB-14F	1